

## HH-2 56 T4 1,1kW (280564106)

### GENERAL DATA



EXTERNAL MOTOR, VARIABLE PITCH BLADES

MANUFACTURING FEATURES:

- Long case fan.
  - Transmission ball bearings set inside a sealed cast iron box.
  - Cast aluminium impeller with variable pitch angle in origin.
  - Polyester powder finishing coat.
  - Standard asynchronous squirrel-cage motor with IP-55 protection and Class F insulation.
- Manufactured with standard voltages: 230V 50Hz in single phase motors and 230/400V 50Hz in three phase motors, up to 4kW and 400/690V 50Hz for higher powers.
- Inspection door.

APPLICATIONS:

Designed for inline installation, they are suitable for:

- Air renewal in buildings and industries.
- Extraction of hot air up to 90°C.
- Maximum working temperature: carried air: 90°C, ambient 60°C.

UNDER REQUEST:

- Supply impeller (air direction from impeller to motor),
- Reversible impeller.
- Polyamide impeller.
- 60Hz fans and special voltages.
- 2 speed motors.
- Hot-dipped galvanised.

### PERFORMANCE CURVE

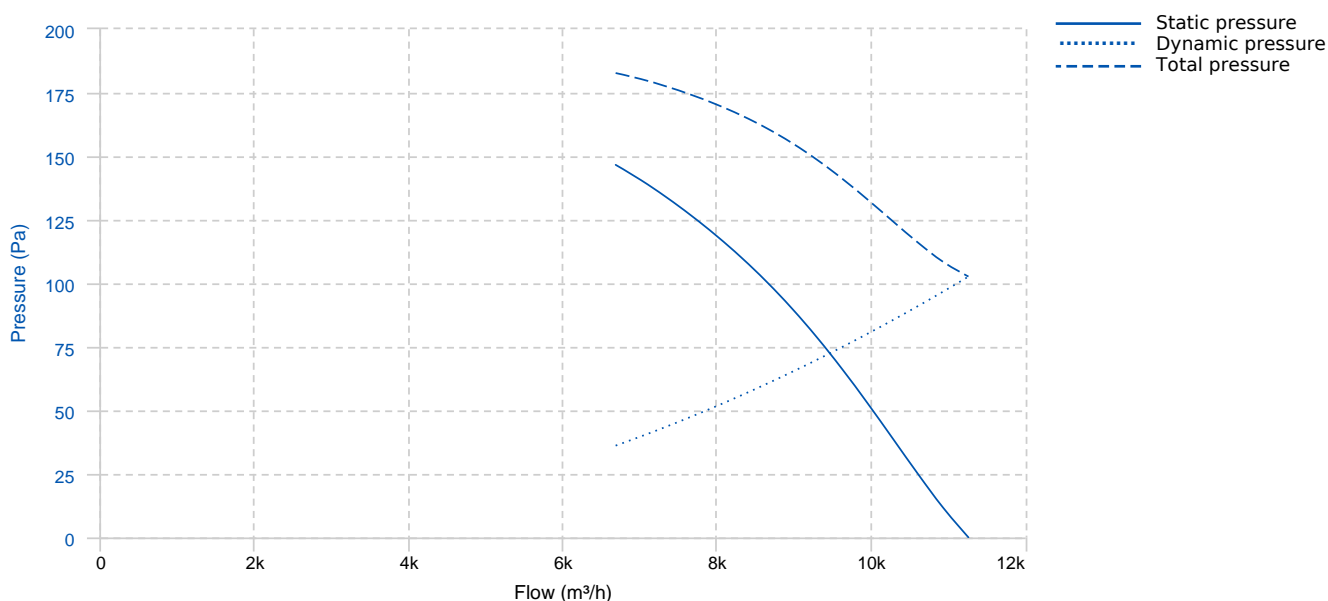

## TECHNICAL DATA

Fan							
RPM	1450	Approx. weight	72 kg	Max. Flow	11260 m <sup>3</sup> /h		
Motor							
Power	1,1 kW	RPM	1450	I max. (230V)	4,33 A	I max. (400V)	2,49 A
Size	90L	Approx. weight	23 kg	Efficiency (%)	84.1 %	FP	0.78

## DIMENSIONS

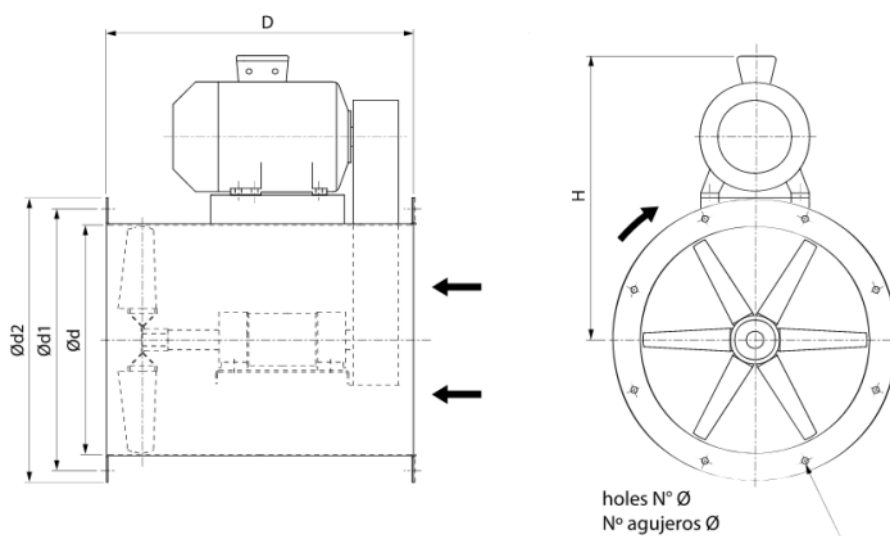

Dimensions (mm)									
D	560	H	570	N	12	d	560	d1	629
d2	665	Ø	14						

## ACCESSORIES



**SAFETY SWITCH**  
INT 25 3P A  
REF: INT253PA



**CONNECTION FLANGE**  
AC 560  
REF: 960003215



**ANTI-VIBRATION JOINT**  
**JE 45**  
**REF: 300719201**



**INLET PROTECTION GUARD FOR CENTRIFUGAL FANS**  
**RA 565x12**  
**REF: 510005600**



**CIRCULAR-CIRCULAR ANTI-VIBRATION FLANGE**  
**BAD 14 (Ø560)**  
**REF: 960003464**



**FREQUENCY SPEED CONTROLLER**  
**SFC 230 I 7A \***  
**REF: SFC230I007**



**FREQUENCY SPEED CONTROLLER**  
**SFC 400 III 3,6A \***  
**REF: SFC400III4**