

## HH-2 80 T4 4kW (280804506)

### GENERAL DATA



EXTERNAL MOTOR, VARIABLE PITCH BLADES

MANUFACTURING FEATURES:

- Long case fan.
  - Transmission ball bearings set inside a sealed cast iron box.
  - Cast aluminium impeller with variable pitch angle in origin.
  - Polyester powder finishing coat.
  - Standard asynchronous squirrel-cage motor with IP-55 protection and Class F insulation.
- Manufactured with standard voltages: 230V 50Hz in single phase motors and 230/400V 50Hz in three phase motors, up to 4kW and 400/690V 50Hz for higher powers.
- Inspection door.

APPLICATIONS:

Designed for inline installation, they are suitable for:

- Air renewal in buildings and industries.
- Extraction of hot air up to 90°C.
- Maximum working temperature: carried air: 90°C, ambient 60°C.

UNDER REQUEST:

- Supply impeller (air direction from impeller to motor),
- Reversible impeller.
- Polyamide impeller.
- 60Hz fans and special voltages.
- 2 speed motors.
- Hot-dipped galvanised.

### PERFORMANCE CURVE

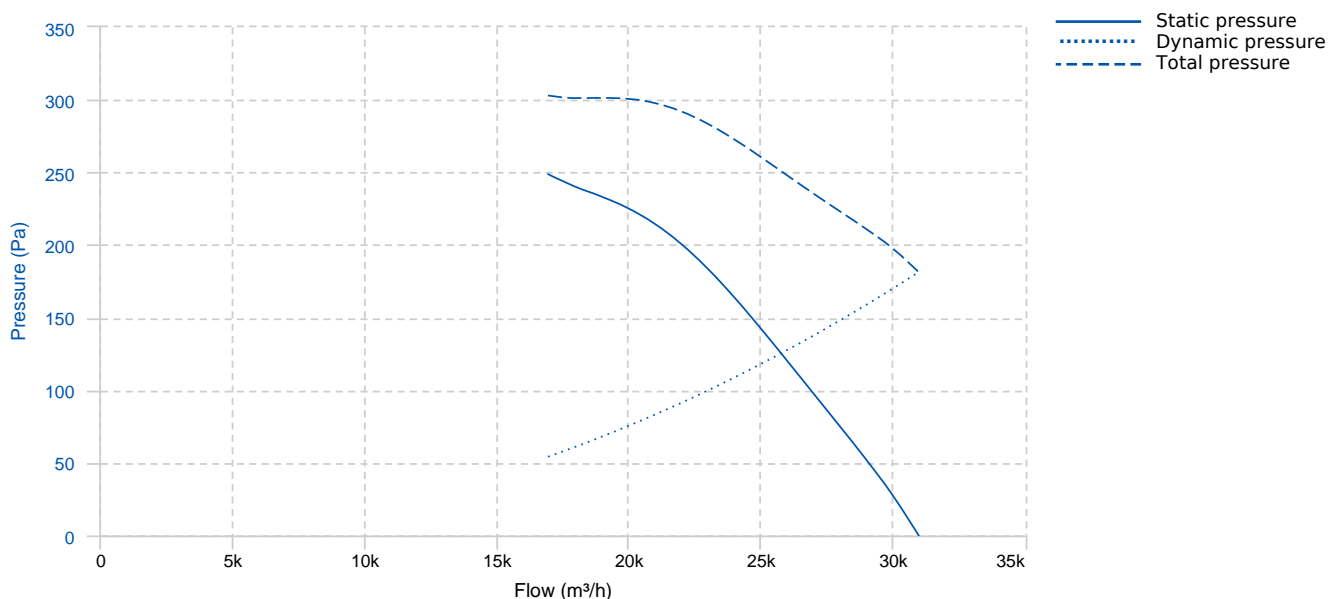

## TECHNICAL DATA

Fan							
RPM	1440	Approx. weight	117 kg	Max. Flow	30970 m <sup>3</sup> /h		
Motor							
Power	4 kW	RPM	1440	I max. (230V)	14,5 A	I max. (400V)	8,32 A
Size	112M	Approx. weight	35.8 kg	Efficiency (%)	86.6 %	FP	0.8

## DIMENSIONS

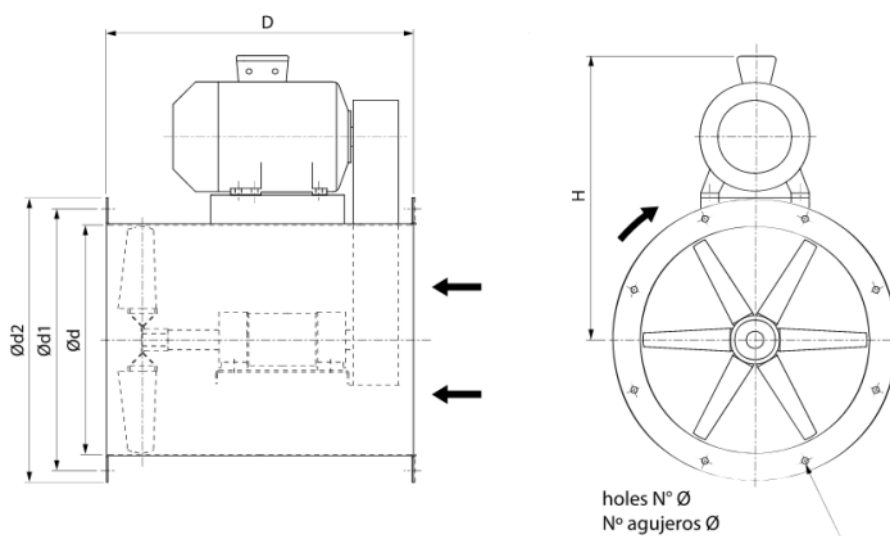

Dimensions (mm)									
D	740	H	730	N	16	d	800	d1	861
d2	905	Ø	14						

## ACCESSORIES



**SAFETY SWITCH**  
INT 25 3P A  
REF: INT253PA



**CONNECTION FLANGE**  
AC 800  
REF: 960003218



**ANTI-VIBRATION JOINT**  
**JE 45**  
**REF: 300719201**



**INLET PROTECTION GUARD FOR CENTRIFUGAL FANS**  
**RA 805x16**  
**REF: 510008000**



**CIRCULAR-CIRCULAR ANTI-VIBRATION FLANGE**  
**BAD 17 (Ø800)**  
**REF: 960003467**



**FREQUENCY SPEED CONTROLLER**  
**SFC 400 III 12A \***  
**REF: SFC400III12**